

Kit 1671

FORD Escape, 5-dr SUV, 13- (Without railing)

FORD Kuga, 5-dr SUV, 08- (Without railing)

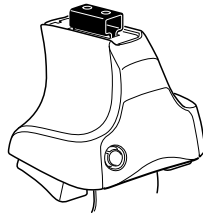

754 Rapid System
480R Rapid Traverse (North America)

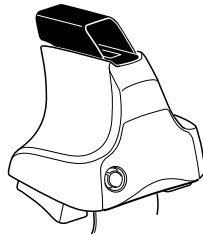
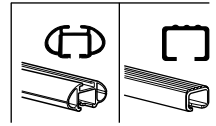

480 Traverse (North America)

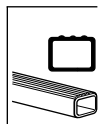

- 754 Rapid System: x1 (box), x4 (cubes), x4 (754 Rapid System), x4 (480R Rapid Traverse (North America)), x4 (screws)
- 480R Rapid Traverse (North America): x1 (ruler), x4 (480R Rapid Traverse (North America)), x4 (screws)
- 480 Traverse (North America): x1 (ruler), x4 (480 Traverse (North America)), x4 (cubes), x4 (screws)

- 23 mm bar: x2
- 17 mm bar: x1
- 23 mm bar: x2
- 23 mm bar: x2
- 23 mm bar: x2
- 23 mm bar: x2
- Hardware: x4, x4
- (North America): x2, x2

- Bracket: x2 (part 287), x2 (part 1030)
- Plate: x1 (part 179), x1 (part 181), x4 (part 256)
- Diagram: x1

1

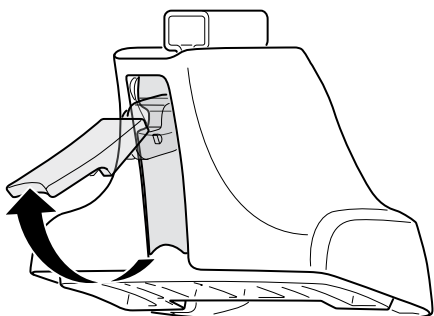

2



754 Rapid System
480R Rapid Traverse
(North America)

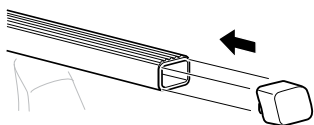
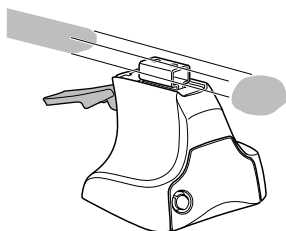

x4

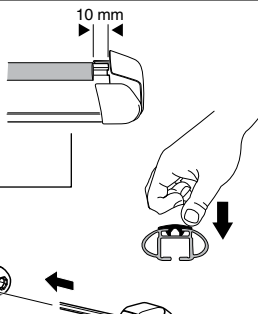
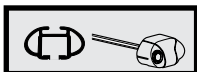

x4

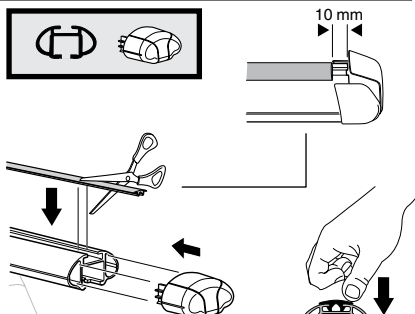
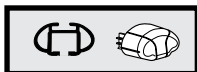

x4



480 Traverse
(North America)

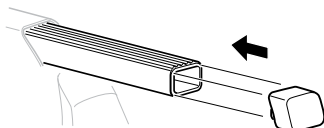
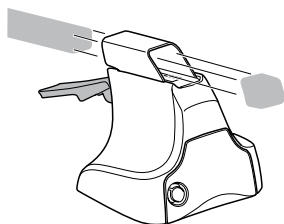

x4

3

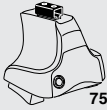

754 Rapid System

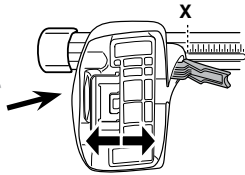

	X
FORD Escape, 5-dr SUV, 13- (Without railing)	41,5
FORD Kuga, 5-dr SUV, 08- (Without railing)	42

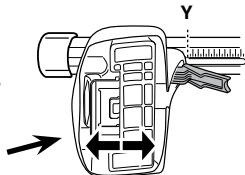

	Y
FORD Escape, 5-dr SUV, 13- (Without railing)	36,5
FORD Kuga, 5-dr SUV, 08- (Without railing)	36

3



480R Rapid Traverse



480 Traverse

(North America)

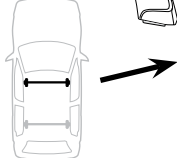

	X inch	X mm
FORD Escape, 5-dr SUV, 13- (Without railing)	42"	1067 mm
FORD Kuga, 5-dr SUV, 08- (Without railing)	42 1/8"	1071 mm

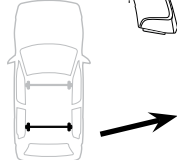

	Y inch	Y mm
FORD Escape, 5-dr SUV, 13- (Without railing)	40"	1016 mm
FORD Kuga, 5-dr SUV, 08- (Without railing)	39 3/4"	1011 mm

4

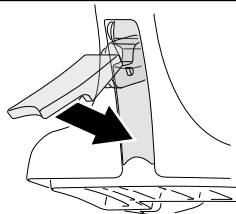

5

FORD Escape, 5-dr SUV, 13- (Without railing)



FORD Kuga, 5-dr SUV, 08- (Without railing)

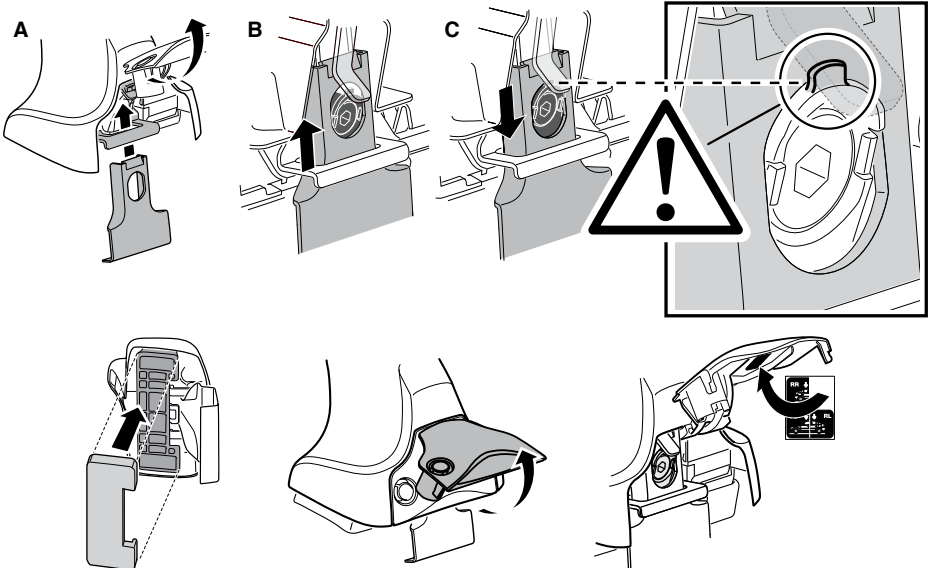

6

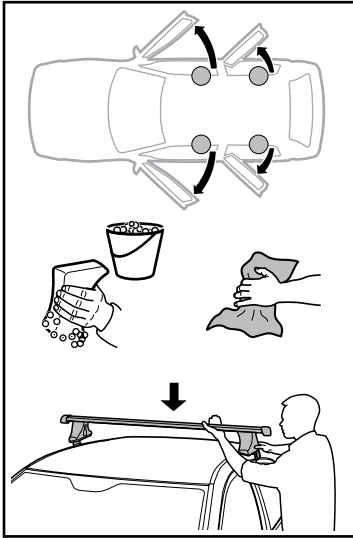

i

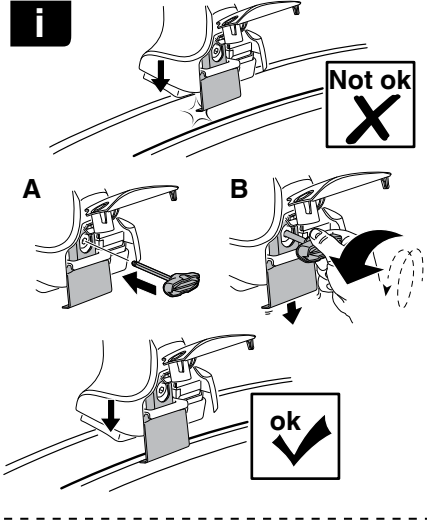

	X mm	Y mm	X inch	Y inch
FORD Escape, 5-dr SUV, 13- (Without railing)	292 mm	711 mm	11 1/2"	28"
FORD Kuga, 5-dr SUV, 08- (Without railing)	320 mm	720 mm	12 5/8"	28 3/8"

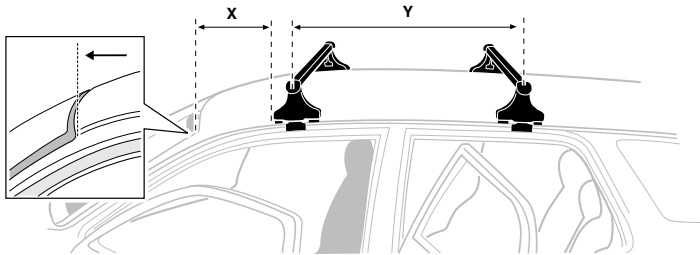

FORD Escape, 5-dr SUV, 13- (Without railing)

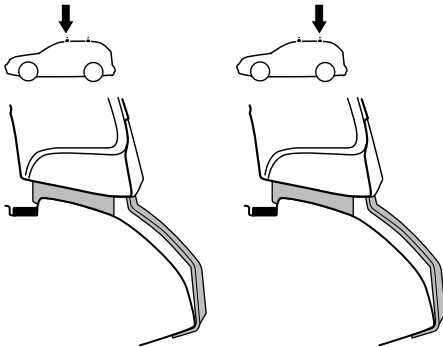

FORD Kuga, 5-dr SUV, 08- (Without railing)

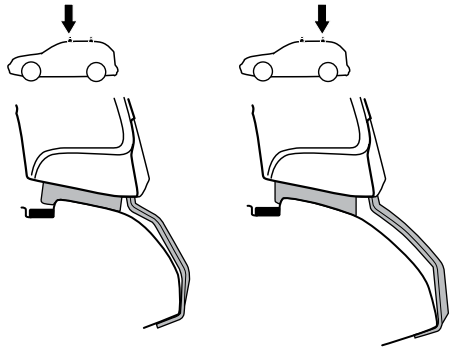

7

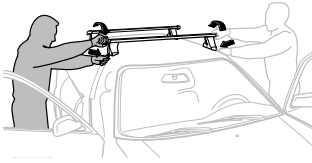

GB/US	Tighten alternately
D	Die Schrauben abwechselnd anziehen
F	Serrer alternativement chaque côté
NL	Afwisselend aan de linker- en de rechterkant aandraaien
I	Alternare il serraggio delle viti
E	Apertar alternativamente
PT	Aperte alternadamente
S	Dra åt växelvis
FIN	Kierrä vuorotellen
EST	Pinguldage vaheldumisi
LAT	Pielveiciet pamišus
LIT	Užsukinėkite pakaitomis
PL	Śruby dokręcaj naprzemiennie
RU	Загряивайте попеременно

CZ	Pokręřta багаžnika dokręcaj naprzemiennie.
SK	Dofahajte striedavo
SLO	Privijajte izmenično.
HR	Naizmjenično zategnite
HU	Egymástól függetlenül szorítandó
GR	Σφιγίγες εναλλάξ
TR	Dönüşümlü sıkın

中文 交替拧紧

한국어 번갈아 가며 조이십시오.

日本語 交互に締め付けてください。

ไทย ชันในแบบสลับ

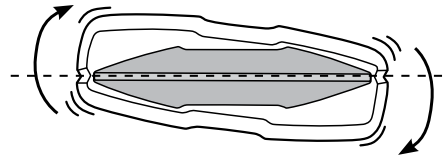
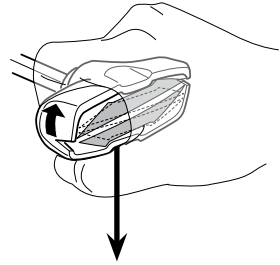
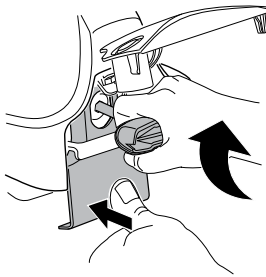
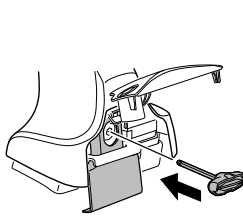

≈ 3 Nm

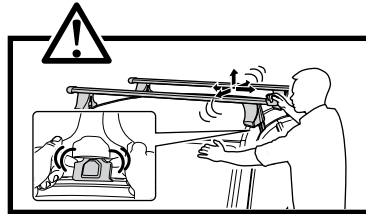
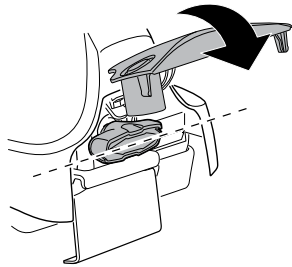

8

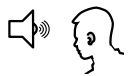
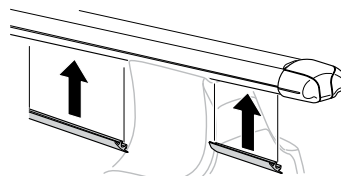
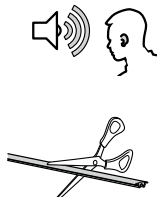
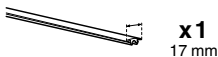

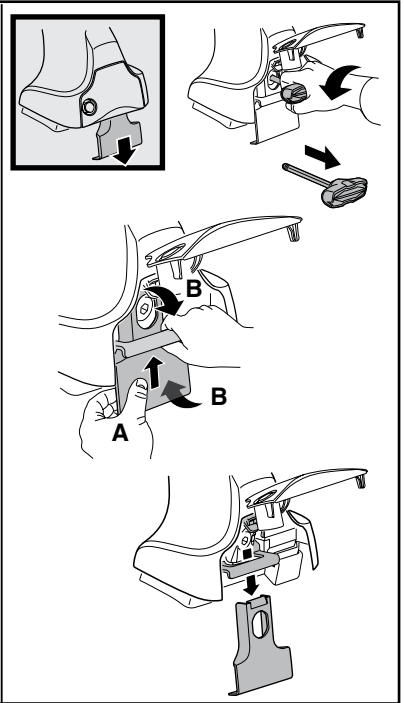
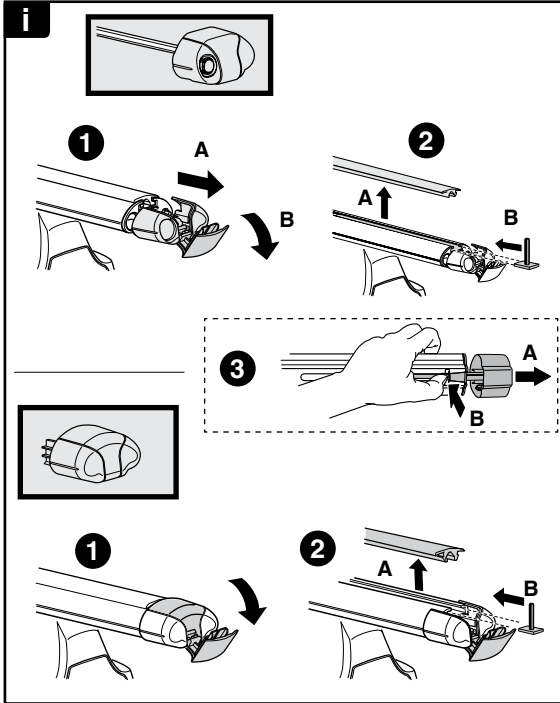
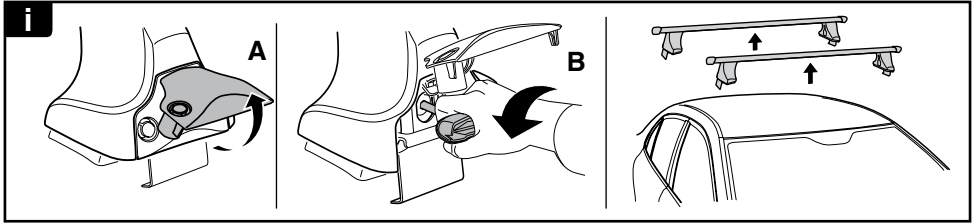

THULE
SWEDEN
**ONE
KEY
SYSTEM**

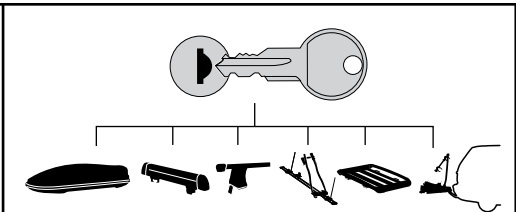

- 544** (x4)
 - 596** (x6)
 - 588** (x8)
 - 510** (x10)
 - 452** (x12)
- NA
EUR
ASIA

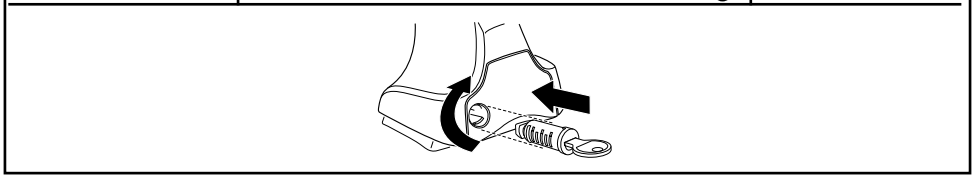

WW ▶ Thule Sweden AB, Box 69, 330 33 Hillerstorp, SWEDEN
NA ▶ Thule Inc., 42 Silvermine Road, Seymour, Connecticut 06483, USA

info@thule.com
customer.service@thule.com

www.thule.com