

# Kit 1210

**SAAB 9-2X**, 5-dr Estate, 04-06

**SUBARU Impreza**, 4-dr Sedan, 01-02, 03-05, 06-07\*

**SUBARU Impreza**, 5-dr Estate, 01-07\*

\* The kit cannot be fitted if the vehicle has a wind deflector.

480R  
754

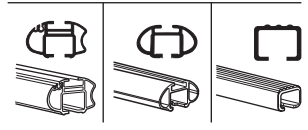
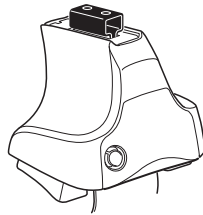

480

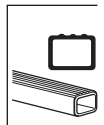
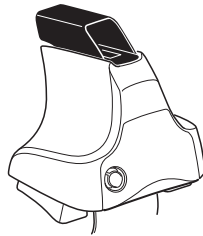

750

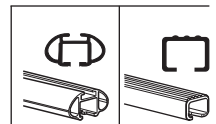
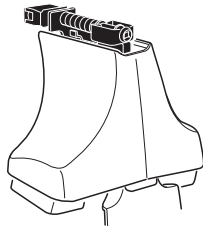

**Kit**

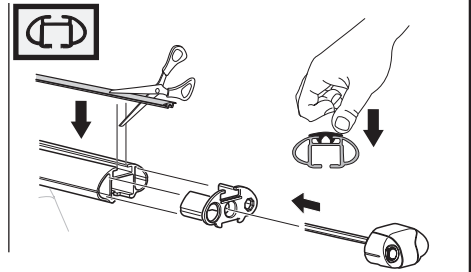
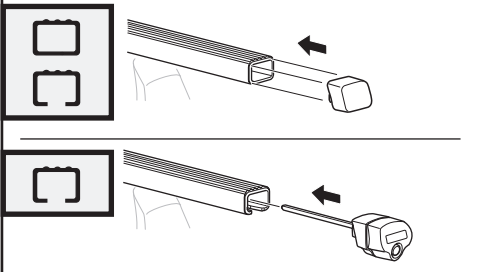
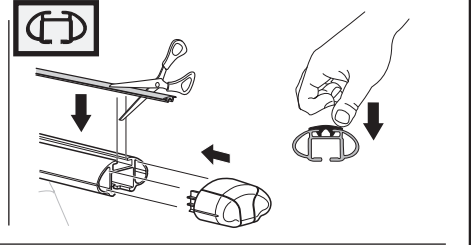
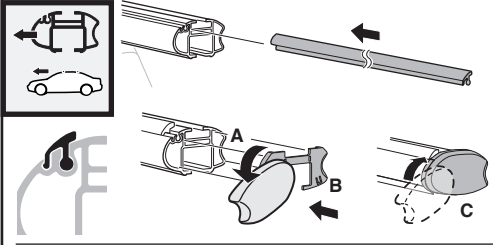
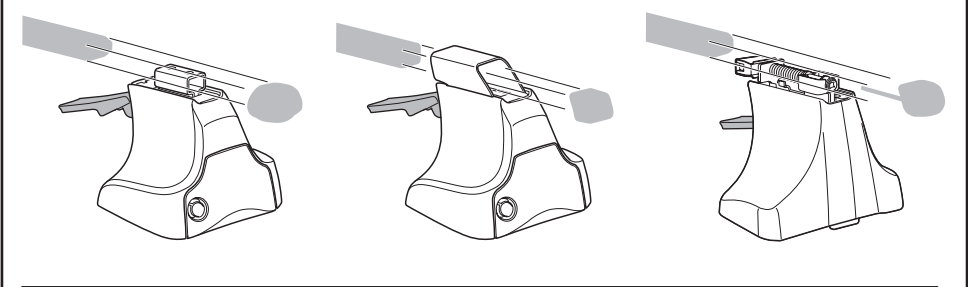
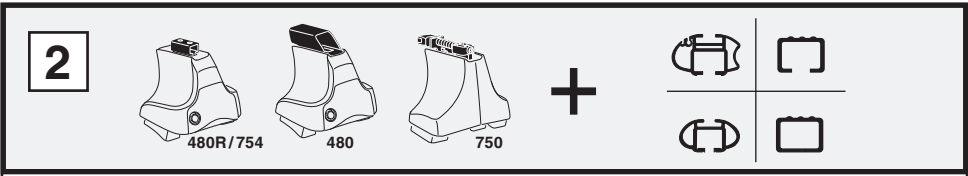
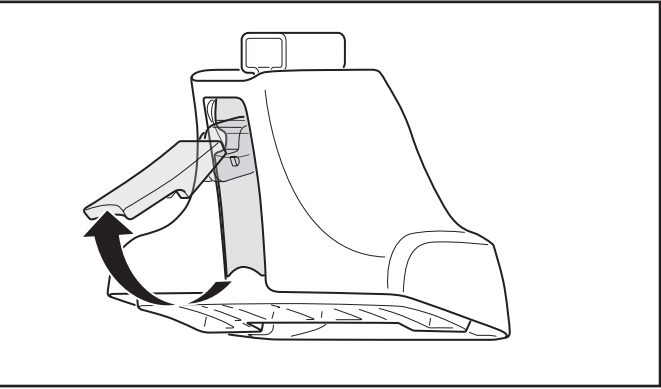
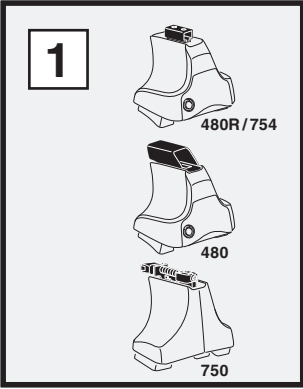

3

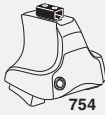

754

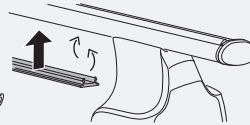
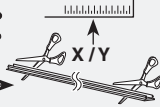

750

1

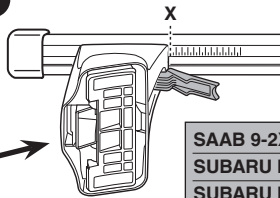
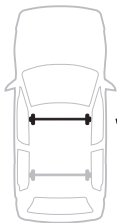

2

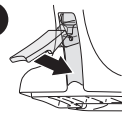

	X
SAAB 9-2X, 5-dr Estate, 04-06	33
SUBARU Impreza, 4-dr Sedan, 01-02, 03-05, 06-07*	35,5
SUBARU Impreza, 5-dr Estate, 01-07*	33

1

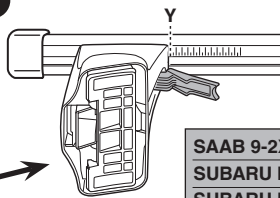

2

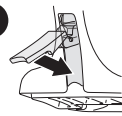

	Y
SAAB 9-2X, 5-dr Estate, 04-06	27,5
SUBARU Impreza, 4-dr Sedan, 01-02, 03-05, 06-07*	28,5
SUBARU Impreza, 5-dr Estate, 01-07*	27,5



480R



480

1

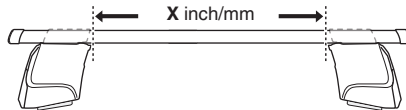

2

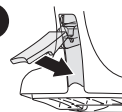

	X inch	X mm
SAAB 9-2X, 5-dr Estate, 04-06	38 <sup>5</sup> / <sub>8</sub> "	981 mm
SUBARU Impreza, 4-dr Sedan, 01-02, 03-05, 06-07*	39 <sup>5</sup> / <sub>8</sub> "	1006 mm
SUBARU Impreza, 5-dr Estate, 01-07*	38 <sup>5</sup> / <sub>8</sub> "	981 mm



1

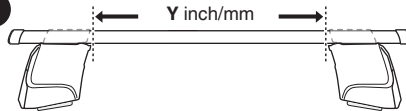

2

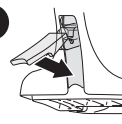

	Y inch	Y mm
SAAB 9-2X, 5-dr Estate, 04-06	36 <sup>1</sup> / <sub>4</sub> "	926 mm
SUBARU Impreza, 4-dr Sedan, 01-02, 03-05, 06-07*	36 <sup>7</sup> / <sub>8</sub> "	936 mm
SUBARU Impreza, 5-dr Estate, 01-07*	36 <sup>1</sup> / <sub>4</sub> "	926 mm

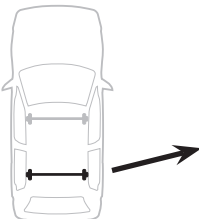

# 4

SAAB 9-2X, 5-dr Estate, 04-06

SUBARU Impreza, 4-dr Sedan, 01-02, 03-05, 06-07\*

SUBARU Impreza, 5-dr Estate, 01-07\*

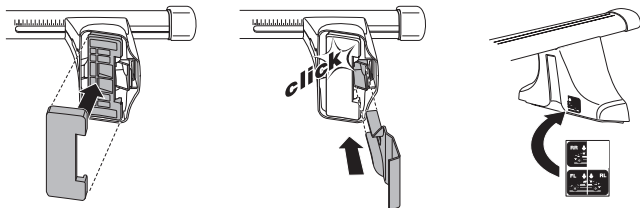
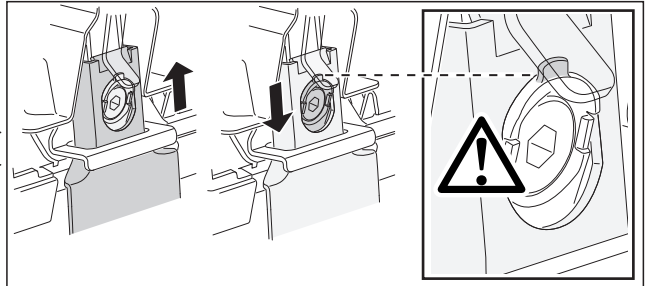
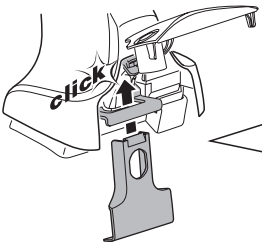
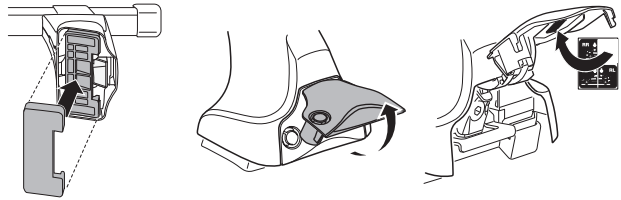
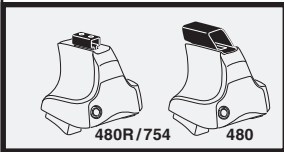
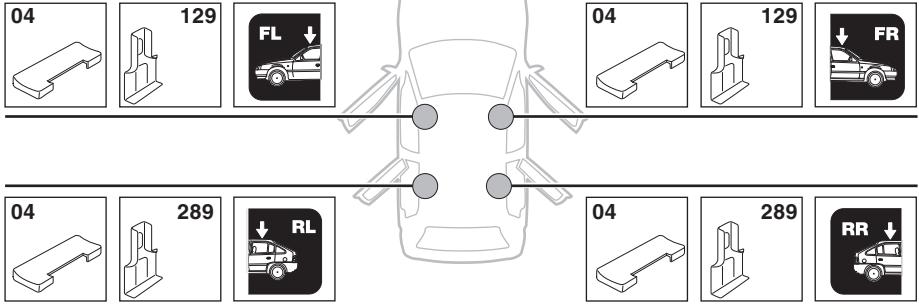

5

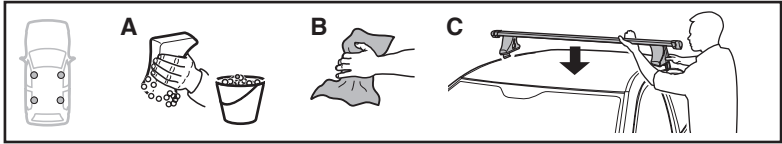

	X mm	Y mm	X inch	Y inch
SAAB 9-2X, 5-dr Estate, 04-06	170 mm	650 mm	6 3/4"	25 5/8"
SUBARU Impreza, 4-dr Sedan, 01-02, 03-05, 06-07*	170 mm	650 mm	6 3/4"	25 5/8"
SUBARU Impreza, 5-dr Estate, 01-07*	170 mm	650 mm	6 3/4"	25 5/8"

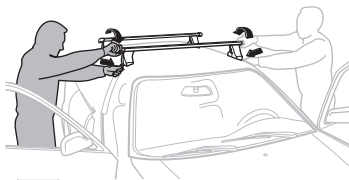
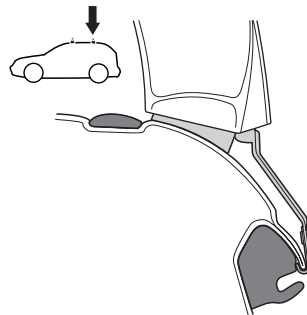
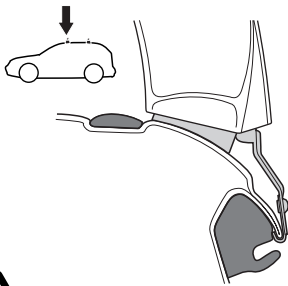
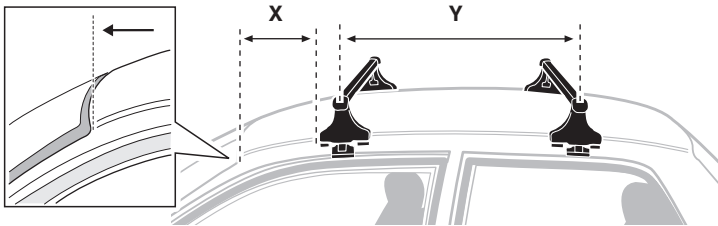

**GB/US** Tighten alternately

**D** Die Schrauben abwechselnd anziehen

**F** Serrer alternativement chaque côté

**NL** Afwisselend aan de linker- en de rechterkant aandraaien

**I** Alternare il serraggio delle viti

**E** Serrare alternativamente

**PT** Aperte alternadamente

**S** Dra åt växelvis

**FIN** Kierrä vuorotellen

**EST** Pinguldage vaheldumisi

**LAT** Pievelciet pamišus

**LIT** Užsukinėkite pakaitomis

**PL** Śruby dokręcaj naprzemiennie

**RU** Затягивайте попеременно

**CZ** Pokręťta bagażníka dokręcaj dokręcaj naprzemiennie.

**SK** Doťahujte striedavo

**SLO** Privijajte izmenično.

**HR** Naizmjenično zategnite

**HU** Egymástól függetlenül szorítandó

**GR** Σφιγγετε εναλλάξ

**TR** Dönüşümlü sıkın

**中文** 交替拧紧

**한국어** 번갈아 가며 조이십시오.

**日本語** 交互に締め付けてください。

**ไทย** ชั้้นโน้บแบบสลับ

6



480R/754



480

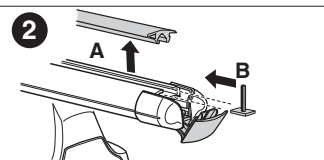
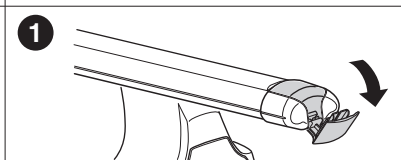
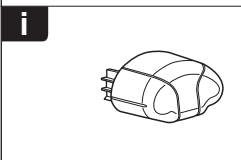
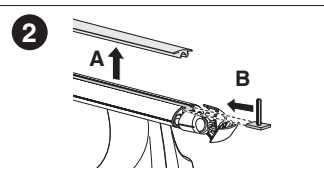
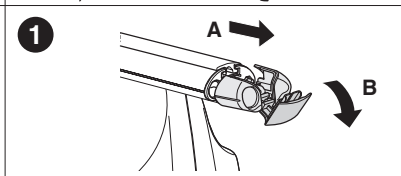
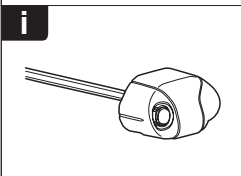
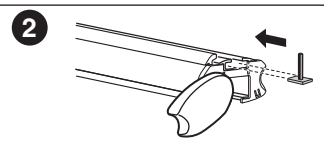
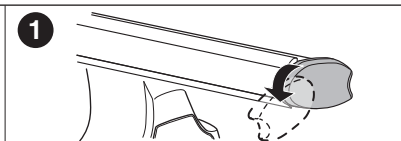
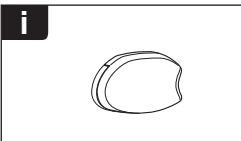
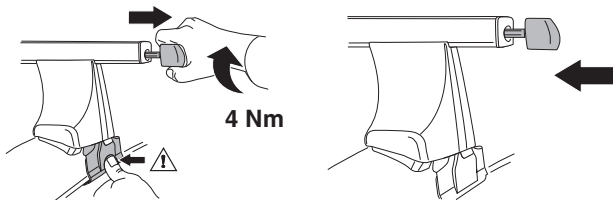
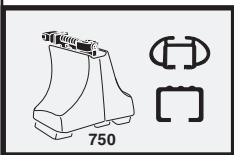
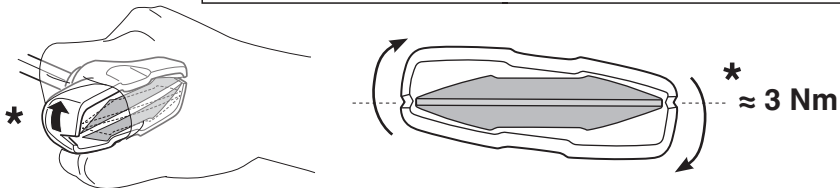
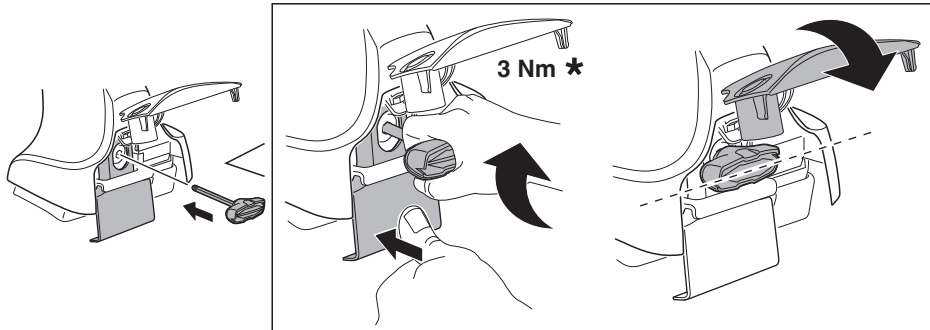

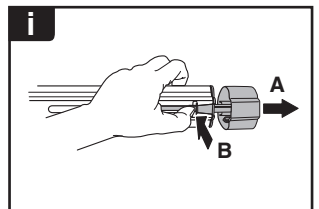
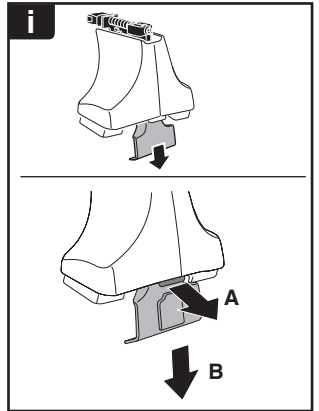
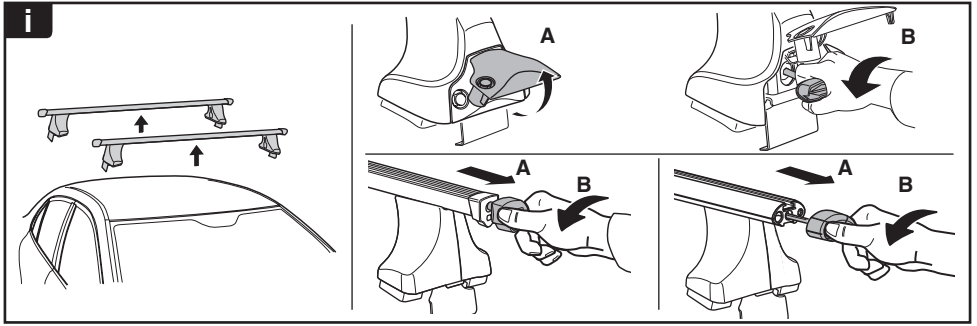

**THULE**  
SWEDEN  
**ONE  
KEY  
SYSTEM**

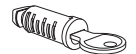
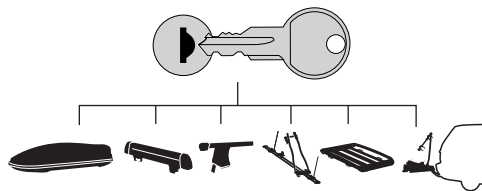

**544** (x4)

**596** (x6)

**588** (x8)

NA **510** (x10)

EUR **452** (x12)

ASIA

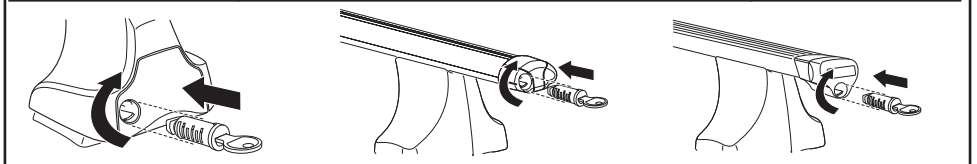

WW ▶ Thule Sweden AB, Box 69, 330 33 Hillerstorp, SWEDEN  
NA ▶ Thule Inc., 42 Silvermine Road, Seymour, Connecticut 06483, USA

info@thule.com  
customer.service@thule.com

www.thule.com