

Kit 1094

VW Beetle, 2-dr Coupé, 98-04, 05-

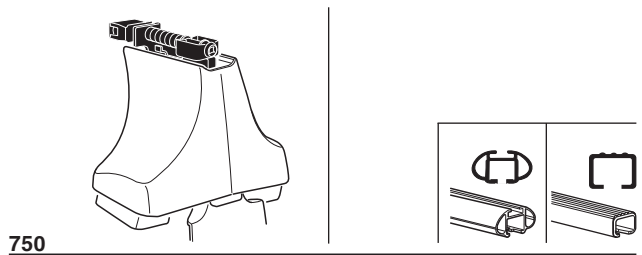
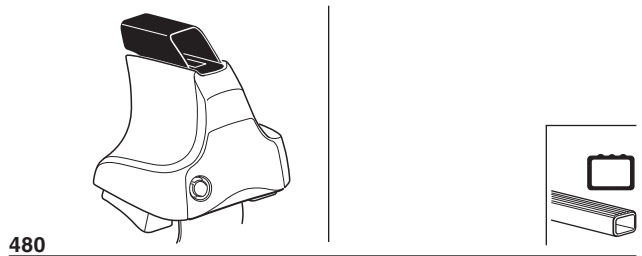
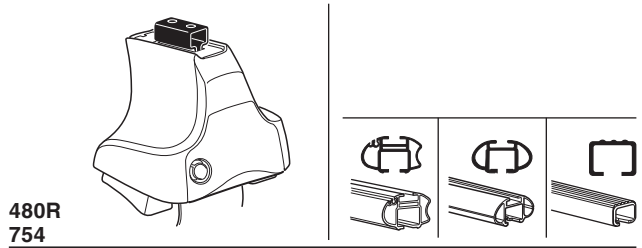

Max. 75kg
Max. 165 lbs

x1
 x4
 x4
 x4
 x4

480R/754

x1
 x4
 x4
 x4

480

x1
 x4
 x4

750

x2	x2	x2	x2	x2
x2	x2	x2	x2	x2
x2	x2	x4	x2	x2
x4		x4		

x2
 x2

x1
 x1
 x1

x1

x1

Kit

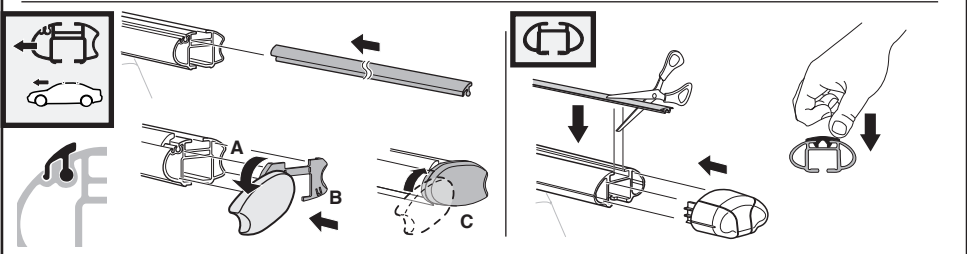
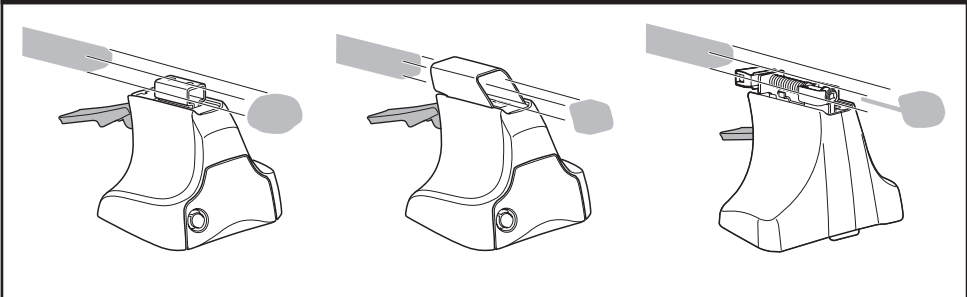

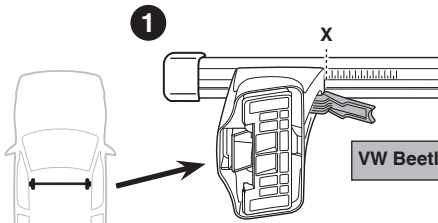
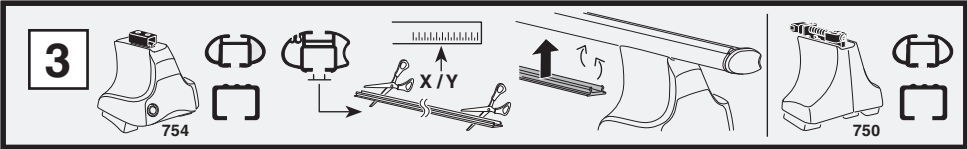

	X
VW Beetle, 2-dr Coupé, 98-04, 05-	33,5

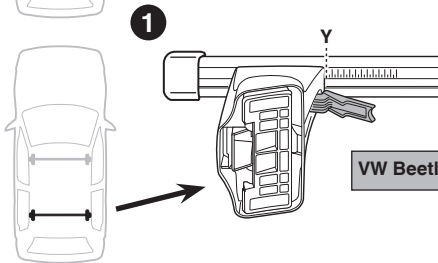

	Y
VW Beetle, 2-dr Coupé, 98-04, 05-	28,5

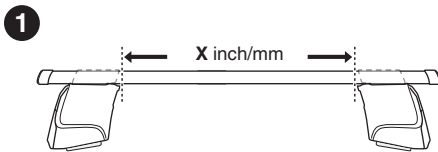
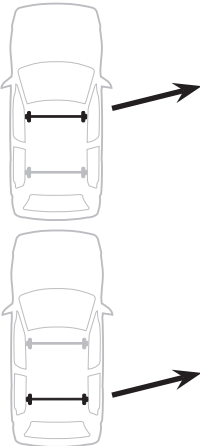
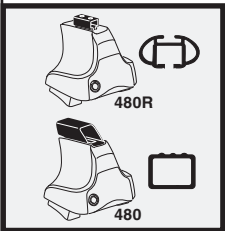

	X inch	X mm
VW Beetle, 2-dr Coupé, 98-04, 05-	38 7/8"	986 mm

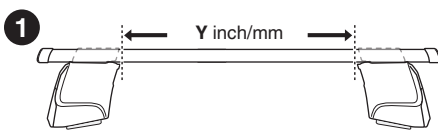
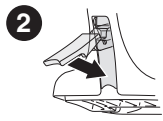

	Y inch	Y mm
VW Beetle, 2-dr Coupé, 98-04, 05-	36 7/8"	936 mm

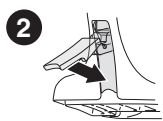

4

VW Beetle, 2-dr Coupé, 98-04, 05-

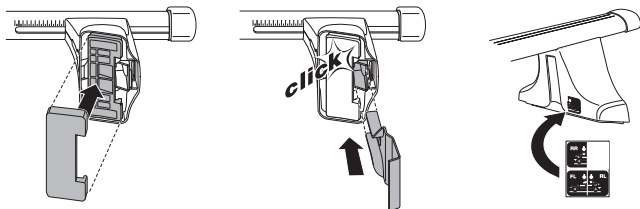
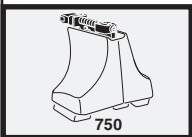
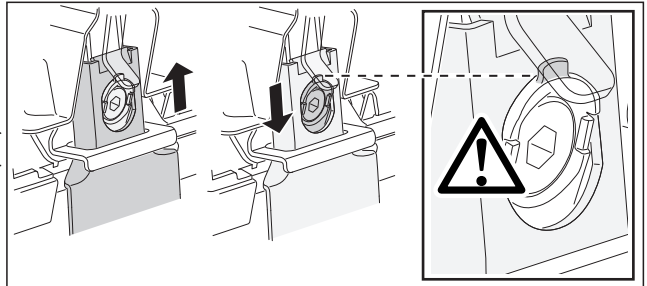
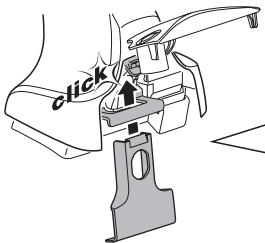
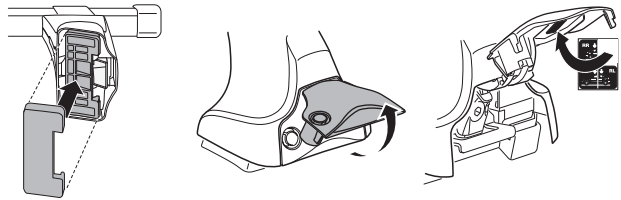
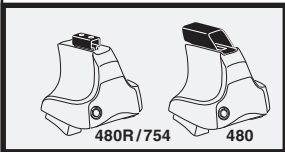
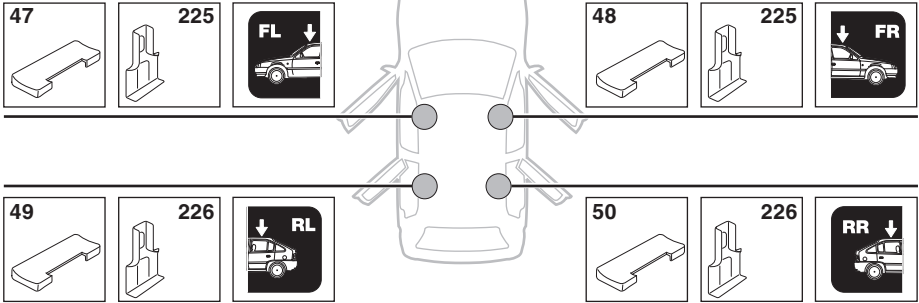

5

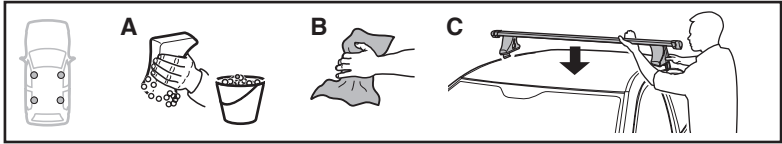

	X mm	Y mm	X inch	Y inch
VW Beetle, 2-dr Coupé, 98-04, 05-	190 mm	700 mm	7 1/2"	27 1/2"

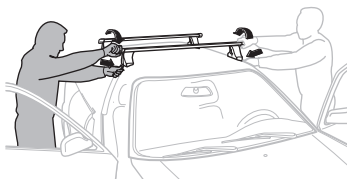
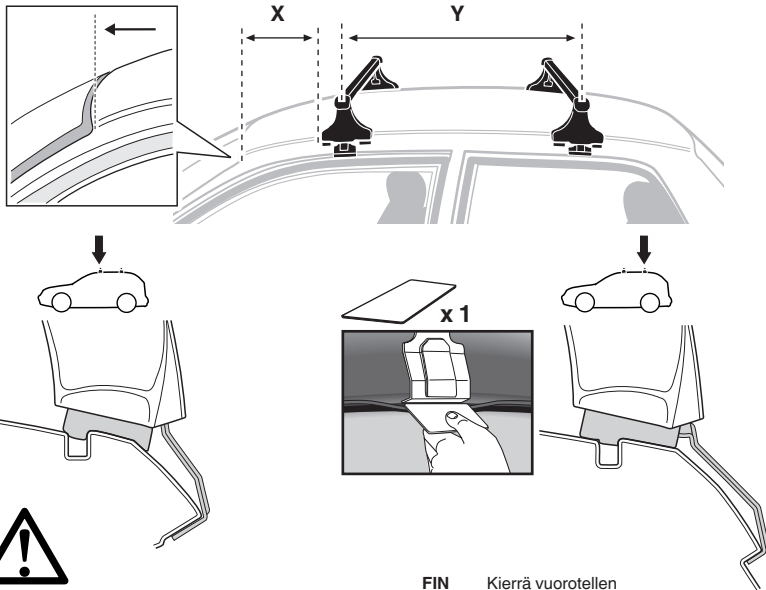

GB/US Tighten alternately

D Die Schrauben abwechselnd anziehen

F Serrer alternativement chaque côté

NL Afwisselend aan de linker- en de rechterkant aandraaien

I Alternare il serraggio delle viti

E Serrare alternativamente

PT Aperte alternadamente

S Dra åt växelvis

FIN Kierrä vuorotellen

EST Pinguldage vaheldumisi

LAT Pieveļciet pamišus

LIT Užsukinėkite pakaitomis

PL Śruby dokręcaj naprzemiennie

RU Затягивайте попеременно

CZ Pokręťta bagażníka dokręcaj dokręcaj naprzemiennie.

SK Doťahujte striedavo

SLO Privijajte izmenično.

HR Naizmjenično zategnite

HU Egymástól függetlenül szorítandó

GR Σφιγγετε εναλλάξ

TR Dönüşümlü sıkın

中文 交替拧紧

한국어 번갈아 가며 조이십시오.

日本語 交互に締め付けてください。

ไทย ชันโนแบบสลับ

6



480R/754



480

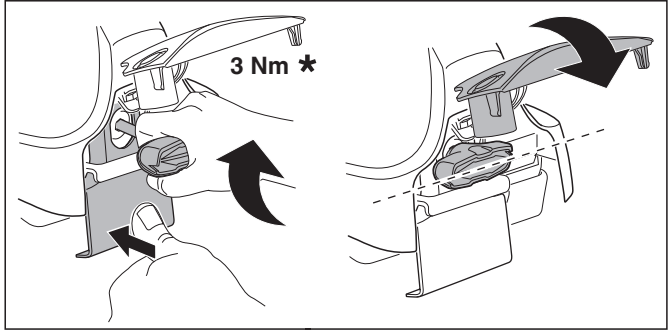
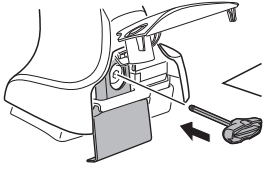

3 Nm *

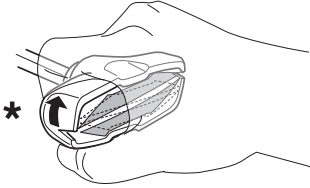

*

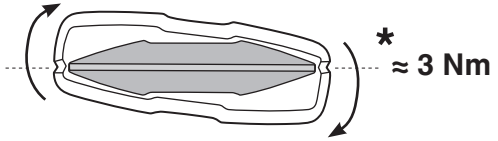

* ≈ 3 Nm

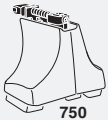

750

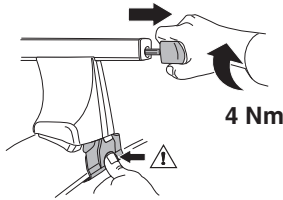

4 Nm

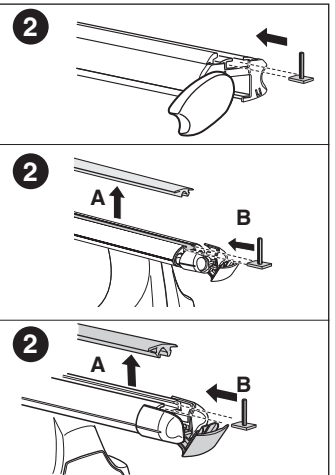
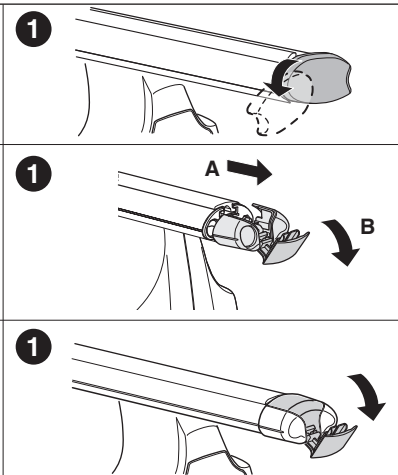
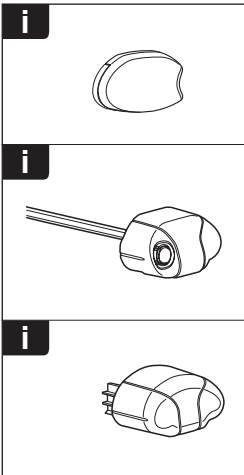
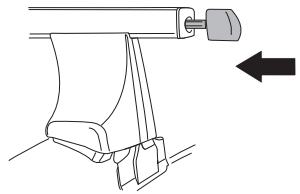

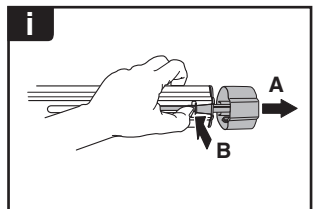
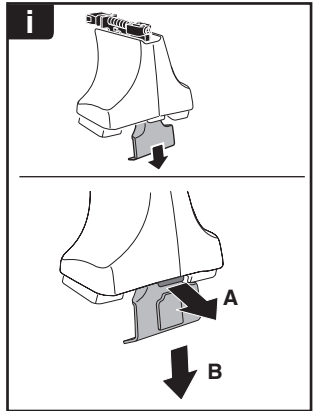
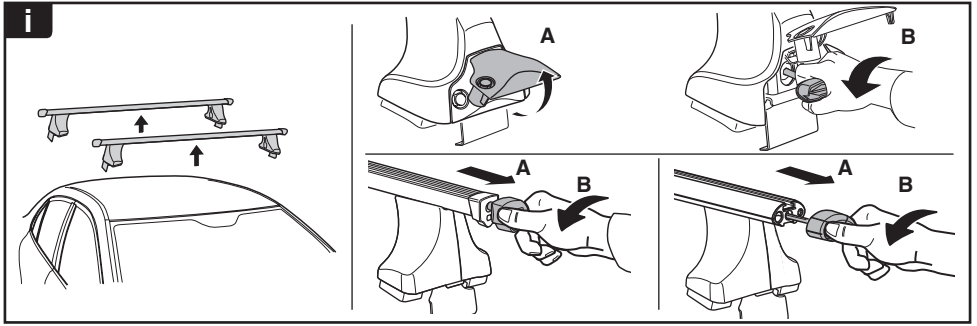

THULE
SWEDEN
**ONE
KEY
SYSTEM**



- 544 (x4)
- 596 (x6)
- 588 (x8)
- NA 510 (x10)
- EUR 452 (x12)
- ASIA

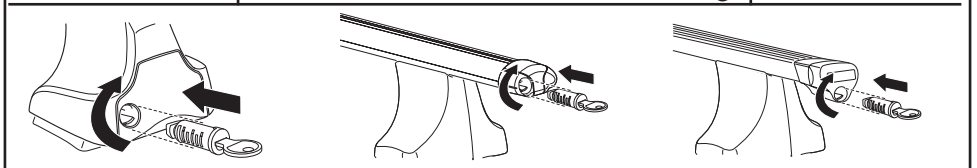

WW ▶ Thule Sweden AB, Box 69, 330 33 Hillerstorp, SWEDEN
NA ▶ Thule Inc., 42 Silvermine Road, Seymour, Connecticut 06483, USA

info@thule.com
customer.service@thule.com

www.thule.com